

Clarke®



INFRARED DIESEL HEATER

MODEL NO: DEVIL IRD20B

PART NO: 6925500

OPERATION & MAINTENANCE INSTRUCTIONS

UK
CA | CE



ORIGINAL INSTRUCTIONS

DL0624 - ISS.7

INTRODUCTION

Thank you for choosing this Clarke Infrared Heater which is ideal for the heating of work areas in large, well ventilated rooms or outbuildings. It is not intended to be used to reach and maintain a certain level of human thermal comfort within an enclosed space in which the product is situated.

Before attempting to use this product, please read this manual thoroughly and follow the instructions carefully. In doing so you will ensure the safety of yourself and that of others around you, and you can look forward to your heater giving you long and satisfactory service.

Please keep these instructions in a safe place for future reference.

FUNCTION AND OPERATING PARAMETERS

This is a multi-fuel (Diesel or Paraffin), forced air heater. It's intended use is for drying and the warming of commercial/industrial buildings where adequate ventilation is provided.

- It must be operated as prescribed in the operating manual.
- It is not intended to be used for domestic use or for the heating of habitable areas.
- It is not intended to be used to reach and maintain a certain level of human thermal comfort within an enclosed space in which the heater is situated.
- It is not intended to be used in enclosed areas with restricted ventilation.
- It is not for use in areas with high levels of fluctuating drafts.
- It is not intended for warming animals or live stock.

GUARANTEE

This product is guaranteed against faulty manufacture for a period of 12 months from the date of purchase. Please keep your receipt which will be required as proof of purchase.

This guarantee is invalid if the product is found to have been abused or tampered with in any way, or not used for the purpose for which it was intended.

Faulty goods should be returned to their place of purchase, no product can be returned to us without prior permission.

This guarantee does not effect your statutory rights.

ENVIRONMENTAL RECYCLING POLICY



Through purchase of this product, the customer is taking on the obligation to deal with the WEEE in accordance with the WEEE regulations in relation to the treatment, recycling & recovery and environmentally sound disposal of the WEEE.

In effect, this means that this product must not be disposed of with general household waste. It must be disposed of according to the laws governing Waste Electrical and Electronic Equipment (WEEE) at a recognised disposal facility.

If disposing of this product or any damaged components, do not dispose of with general waste. This product contains valuable raw materials. Metal products should be taken to your local civic amenity site for recycling of metal products.

TECHNICAL SPECIFICATION

Dimensions (L x W x H)	575 x 340 x 635 mm
Weight (empty)	18.5 kg
Fuel	Diesel/paraffin
Fuel consumption	1.9 L per hour
Fuel Tank capacity	10.5 litres
Ignition type	Direct spark
Air displacement	400 m ³ /hr
Continuous working time	6 hr (before re-fueling)
Over heating protection	120°C
Max output	20 kW (68242 Btu/h)
Selectable operating temperature	+5°C to +45°C
Duty cycle	S1 (continuous)
Fuel pump pressure	15 bar
Electrical supply	230V 50 Hz 1 ph
Protection degree	IPX4
Sound pressure level	65 dB LpA

GENERAL SAFETY PRECAUTIONS



CAUTION: FAILURE TO FOLLOW THESE PRECAUTIONS COULD RESULT IN PERSONAL INJURY, AND/OR DAMAGE TO PROPERTY.

CAUTION: DUE TO THE HIGH SURFACE AND EXHAUST TEMPERATURES, ADULTS, CHILDREN AND ANIMALS MUST KEEP CLEAR OF THE UNIT TO AVOID BURNS OR CLOTHING IGNITION.

GENERAL

1. **ALWAYS** read and ensure you fully understand the following precautions and the hazards associated with this heater. **DO NOT** allow anyone who has not read these instructions to operate it.
2. **NEVER** carry out any modifications to this heater. If experiencing difficulty of any kind consult your local Clarke dealer.
3. Only use the heater in accordance with any applicable fire, local building and/or site regulations.

OPERATING ENVIRONMENT

1. This heater is intended for drying & warming of commercial/industrial buildings where adequate ventilation is provided. It is **NOT** for domestic use or for heating habitable areas.
2. The heater should **NOT** be used by children or persons with reduced physical, sensory or mental capabilities, or lack of experience and knowledge.
3. **DO NOT** expose the heater or power cable to rain or wet conditions. Any water entering the heater will increase the risk of electric shock.
4. **NEVER** use the heater where petrol, paint thinners or other highly flammable vapour may be present.
5. The heater should **ALWAYS** be positioned well away from sources of air-borne dust, as ingress of dust into the heater may cause it to malfunction. It will be beneficial to shield the heater from a dusty work environment.
6. **NEVER** locate the heater facing curtains or other combustible materials. **ALWAYS** keep combustibles at least 2.5 m from the front of the heater.
7. Never place anything on top of the heater.
8. **ALWAYS** locate the heater on a level, flat, fireproof surface. Ensure that the heater is correctly and safely positioned as described on page 10.
9. **DO NOT** use this heater in the immediate surrounds of a bath, a shower or a swimming pool.

10. **DO NOT** use this heater in small rooms when they are occupied by persons not capable of leaving the room on their own unless constant supervision is provided.
11. Disconnect the heater from the power supply when not in use.
12. **DO NOT** locate the heater close to an adjacent wall or ceiling. Avoid placing the heater directly below power socket outlets.

PERSONAL SAFETY

1. When the heater is used in the presence of other people the user is responsible for informing those present of the safety precautions and of the hazards involved.
2. The heater is not to be used by children or people with reduced physical, sensory or mental capabilities, or lack of knowledge.
3. **ALWAYS** ensure that people and animals are at least 2.5 m away from the front of the heater when in operation.
4. **NEVER** leave a heater unsupervised while in use - someone should always be made responsible for monitoring it.
5. **DO NOT** move or service the heater while hot or in use.
6. This heater will be hot when in use and should not be touched until it has fully cooled down after shutting down.

REFUELLING

1. **ALWAYS** refuel in a well ventilated area.
2. **ALWAYS** allow the heater to cool down before re-fuelling and refuel away from any source of heat.
3. **NEVER** overfill the tank, only fill to the level specified.
4. Use only clean diesel or paraffin. **NEVER** use gasoline, paint thinners, alcohol or other highly flammable fuels.
5. Take care not to spill diesel or paraffin onto the power cable as this could damage the insulation.
6. **NEVER** move, replenish the fuel supply or handle the heater when it is hot, or in use. Turn it off and wait for it to cool down first.

ELECTRICAL SAFETY

1. Electrical appliances must match the power outlet. Never modify the plug in any way. **DO NOT** use adaptor plugs with earthed (grounded) appliances. Correct plugs and outlets will reduce the risk of electric shock.
2. **DO NOT** abuse the electrical cable by using it to pull or unplug the heater. Keep the cable away from sources of heat, oil, sharp edges or moving

parts. **DO NOT** use if it is damaged, damaged or tangled cables increase the risk of electric shock.

3. Keep the mains cable well away from machines and ensure an adequate electrical supply is close at hand so that the operation is not restricted by the length of the cable.
4. **ALWAYS** disconnect from the mains supply before moving the heater or performing any maintenance tasks.
5. **DO NOT** use this heater with a programmer, timer, separate remote control system or any device that switches the heater on automatically, since a fire risk exists if the heater is covered or positioned incorrectly.

SAFETY SYSTEMS

The unit is fitted with a temperature limit sensor, which is designed to turn the heater off if the temperature should rise to an unsafe level. If the sensor is tripped and the heater is turned off it may require a service. Once the temperature falls back below the reset temperature, the heater should re-start.

The heater is fitted with an electrical circuit breaker to protect the internal components from damage. If the heater should fail to work, this fuse may require checking by your dealer.



The heater is fitted with a tilt switch designed to turn the unit off immediately if it should tip over beyond a pre-determined angle.

SERVICE & REPAIRS

1. Check the heater for damage before use. **DO NOT** use if the heater is damaged or dropped. Any damage should be properly repaired or the part replaced. If in doubt, **DO NOT** use the heater. Consult your local dealer.
2. When necessary, have your heater serviced or repaired by a qualified person using identical replacement parts. This will ensure that the safety of the heater is maintained.

SAFETY SYMBOLS

The following symbols appear on the heater.

	Hot Surface, DO NOT TOUCH		DO NOT COVER
---	----------------------------------	---	---------------------

ELECTRICAL CONNECTIONS



WARNING: READ THESE ELECTRICAL SAFETY INSTRUCTIONS THOROUGHLY BEFORE CONNECTING THE PRODUCT TO THE MAINS SUPPLY.

Before switching the product on, make sure that the voltage of your electricity supply is the same as that indicated on the rating plate. This product is designed to operate on 230VAC 50Hz. Connecting it to any other power source may cause damage.

This product may be fitted with a non-rewireable plug. If it is necessary to change the fuse in the plug, the fuse cover must be refitted. If the fuse cover becomes lost or damaged, the plug must not be used until a suitable replacement is obtained.

If the plug has to be changed because it is not suitable for your socket, or due to damage, it should be cut off and a replacement fitted, following the wiring instructions shown below. The old plug must be disposed of safely, as insertion into a mains socket could cause an electrical hazard.

If the colours of the wires in the power cable of this product do not correspond with the markings on the terminals of your plug, proceed as follows.

- The wire which is coloured **Blue** must be connected to the terminal which is marked **N** or coloured **Black**.
- The wire which is coloured **Brown** must be connected to the terminal which is marked **L** or coloured **Red**.
- The wire which is coloured **Yellow and Green** must be connected to the terminal which is marked **E** or  or coloured **Green**.

Plug must be BS1363/A approved.

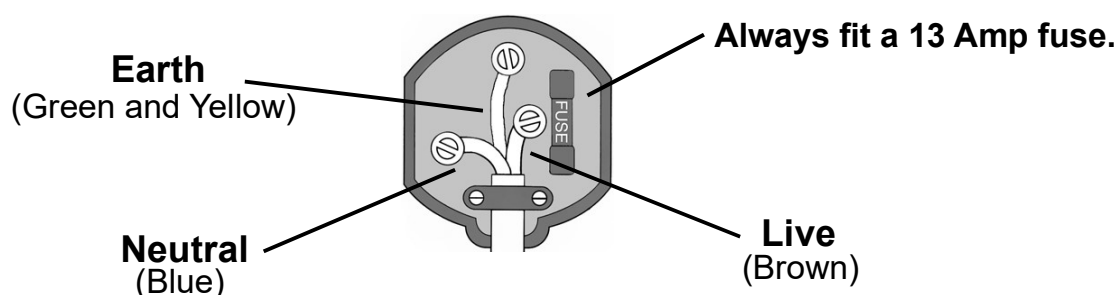

Ensure that the outer sheath of the cable is firmly held by the clamp

We strongly recommend that this machine is connected to the mains supply via a Residual Current Device (RCD). If in any doubt, consult a qualified electrician. **DO NOT** attempt any repairs yourself.

DEVIL IRD20B HEATER OVERVIEW



1	Power-on LED
2	Digital temperature display
3	Power switch
4	Temperature control knob

5	Fuel gauge
6	Fuel tank
7	Fuel filler cap

The heater is supplied with a spare fuel filter, tank drain bolt and sealing washer. Fixings are supplied to connect the stand, heatshield and handle which are supplied loose.

PREPARATION

UNPACKING

1. Remove heater from carton, and remove all protective material used for shipment.
2. Check the heater for any damage and notify your Clarke dealer immediately should any be apparent.

NOTE: THERE MAY BE SOME DISCOLOURATION TO THE HEATING ELEMENT, THIS IS DUE TO THE HEATER BEING TESTED DURING THE MANUFACTURING PROCESS. THIS DOES NOT INDICATE A FAULT.

3. Fit the carrying handle to the top of the heater using the screws supplied.

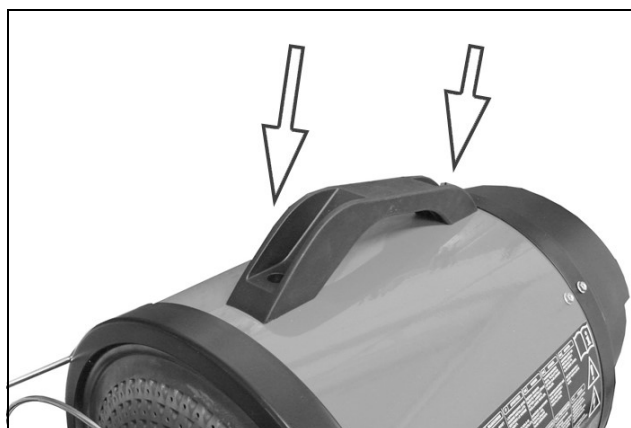

4. Fit the heatshield to the heater body using the screws supplied.

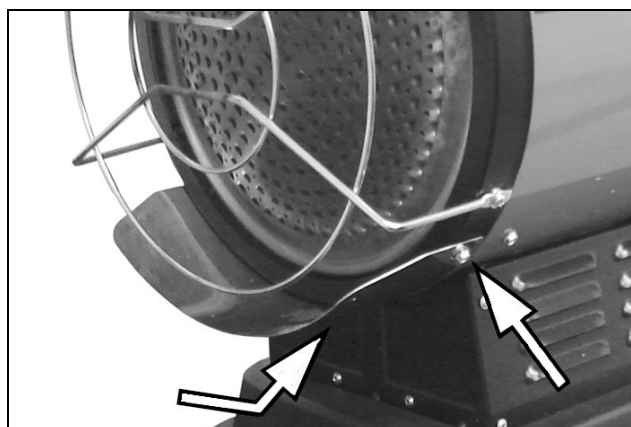

5. Fit the stand to the fuel tank using the fixings supplied. Note the correct orientation.



SUITABLE FUELS

Diesel or paraffin are the only fuels that should be used in this heater.

FILLING THE FUEL TANK

IMPORTANT: In cold weather, condensation may develop in the tank if the tank is empty. Before filling the fuel tank for the first time or after extended storage periods, vent the fuel tank of any moisture or condensation.

1. Follow all of the "Safety Precautions".
2. Remove the fuel cap.

NOTE: If you lose the fuel cap a replacement must be obtained before use, this is available from the Clarke service department.

3. Fill the fuel tank with clean diesel or paraffin.
4. When refilling, inspect the mesh filter inside the filler neck for any trapped contamination and clean out if necessary.

- When filling the heater, make sure that the heater is level and do not overfill. Use a funnel or can with a long filling spout.
- Fill with a minimum of 4 litres of fuel.

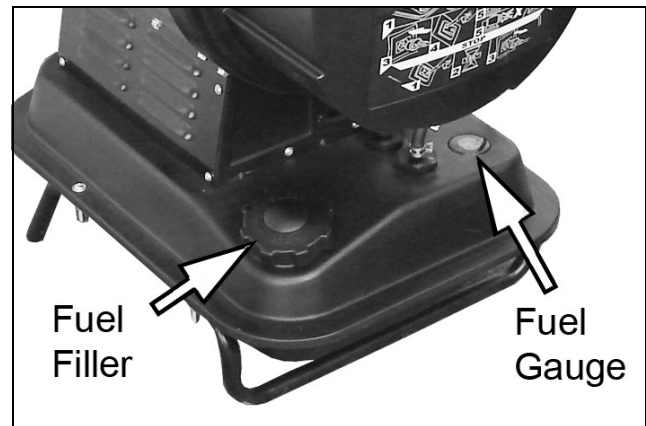

POSITIONING THE HEATER

The heater should not be used in habitable areas. It must be located on a hard, level surface to minimise the risk of accidentally tipping over. The heater is not suitable for use on wood floors or other combustible materials. It should be stood on suitable insulating material at least 26 mm thick and extending 1m or more in all directions.

When the heater is in use, periodically monitor any buildup of heat on nearby surfaces.

It is important that the heater is positioned with at least 2.5 m clearance at the front between the heater and any objects or surfaces. Always position the heater facing the centre of the room, not pointing directly at any nearby surfaces. Never place any objects on, or against the heater.

Any equipment or workshop furniture should be a safe distance away as they could be adversely affected by heat.

The heater should always be positioned well away from sources of airborne dust, as ingress of dust into the heater may cause it to malfunction. It will be beneficial to shield the heater from a dusty work environment.

VENTILATION

Even though this heater operates very close to 100 percent combustion efficiency, it still produces small amounts of carbon monoxide.

Carbon monoxide (CO) is toxic and can build up in a confined spaces and failure to provide adequate ventilation can be fatal.

The early symptoms of asphyxiation caused by inadequate ventilation are:

- headache
 - dizziness
 - nausea
 - dry mouth or sore throat
1. Only use in well ventilated areas and make sure that ample ventilation is present if the heater is being started following a long period without use.
 2. **NEVER** attach any duct work to the front of the heater.
 3. **NEVER** cover or impede airflow into or out of the heater.

WE RECOMMEND THE USE OF A CARBON MONOXIDE DETECTOR

OPERATION

HEATER START UP

1. Plug the heater into the mains power supply.
2. Set the power switch to the ON position.
 - The 'power-on' LED will illuminate and the digital temperature display will show the room temperature for up to 3 minutes.
 - Turn the temperature control knob to adjust the target temperature required. This setting will be shown by the digital display.

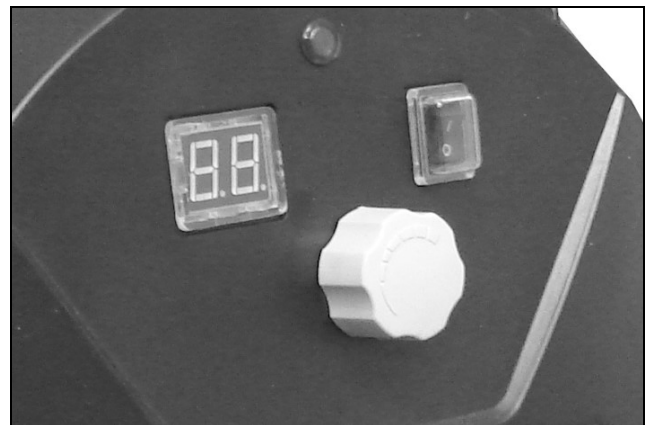

NOTE: If the heater does not start up, the temperature control may be set too low. Turn the control knob to a higher setting until the heater starts. If the heater does not start, switch the power switch off, then switch back on again. If the heater still does not start, refer to fault-finding guide on page 13. Also check that the power supply is correct.

FAULT CODE DISPLAY

The digital display can show the following fault codes.

FAULT CODE	CAUSE	SOLUTION
FO:- Operation error	1. Heater is switched on before being plugged in.	1. Disconnect from power supply, switch off and then plug in again before switching on.
F1:- Photocell error	1. No fuel 2. Fuel is contaminated 3. Photocell is dirty or damaged. 4. Fuel Filter is dirty. 5. Ignition error	1. Switch off and refill the tank. 2. Switch off, empty and refill the fuel tank. Clean the filter with clean fuel. 3. Contact your dealer. 4. Clean filter. 5. Contact your dealer.
F2:- Temperature control sensor error	1. Damaged cable 2. Sensor is damaged.	1. Contact your dealer. 2. Contact your dealer.
F3:- Thermostat error	1. Internal parts over heating. 2. Anti-tilting sensor activated.	1. Turn the heater off and wait until it has cooled down. 2. Reposition heater on a level surface.
LO	1. External temperature below -9°C	1. Wait for normal temperature conditions
CH	1. Air temperature over 55°C.	1. Wait for normal temperature conditions

HEATER SHUT DOWN & RE-STARTING

1. Set the power switch to the OFF position but do not unplug from the mains.

NOTE: When the heater is shut down, the fan will continue running for 5 minutes to expel hot air and cool the casing. For this reason the heater should not be unplugged.

2. Only for extended shutdown should the heater be unplugged from the mains supply.
3. If re-starting, wait 10 seconds after shutting off the heater before re-starting.
4. Set the power switch to the ON position and follow the startup procedure above.

FAULT FINDING

Problem	Cause	Solution
Heater fires but shuts off after a short period of time.	<ol style="list-style-type: none"> 1. Dirty fuel filter 2. Nozzle is dirty 3. Photocell lens is dirty 4. Photocell not installed correctly. 5. Photocell defective 6. Bad connection between PCB and photocell 	<ol style="list-style-type: none"> 1. Clean/replace fuel filter 2. Clean/replace nozzle 3. Clean photocell 4. Adjust photocell position 5. Return to dealer for new photocell 6. Ask dealer to check wiring connections
Heater will not operate	<ol style="list-style-type: none"> 1. No fuel in tank 2. Corroded spark plug or incorrect plug gap 3. Dirty fuel filter 4. Dirty nozzle 5. Moisture in fuel/tank 6. Bad electrical connection between transformer and PCB 7. Igniter wire not connected to sparkplug 8. Defective igniter 	<ol style="list-style-type: none"> 1. Fill tank with fresh fuel. 2. Ask dealer to clean/re-gap/replace spark plug 3. Clean/replace fuel filter 4. Ask dealer to clean/replace nozzle. 5. Rinse out fuel tank with clean, fresh fuel. 6. Return to dealer. 7. Return to dealer for repair. 8. Return to dealer for repair.
Fan does not operate when heater is switched on.	<ol style="list-style-type: none"> 1. Thermostat is set too low 2. Broken electrical connection between main PCB and motor. 	<ol style="list-style-type: none"> 1. Turn the thermostat to a higher setting 2. Ask dealer to check all electrical connections.
Poor combustion and/or excessive soot production.	<ol style="list-style-type: none"> 1. Dirty fuel filter 2. Poor quality fuel. 	<ol style="list-style-type: none"> 1. Clean/replace fuel filter 2. Check that fuel is not contaminated or old.
Heater does not turn on and the lamp does not light.	<ol style="list-style-type: none"> 1. Temperature limit sensor has overheated. 2. No electrical power 3. Fuse blown 4. Bad connection between temperature limit sensor and PCB. 	<ol style="list-style-type: none"> 1. Set the power switch to off and allow the heater to cool for 10mins before switching back on. 2. Check the power cable for good connection. Test the power supply. 3. Return to dealer for repair. 4. Return to dealer for repair.

CLEANING AND MAINTENANCE



WARNING: BEFORE CARRYING OUT ANY MAINTENANCE, ENSURE THE HEATER IS SWITCHED OFF, DISCONNECTED FROM THE MAINS SUPPLY AND HAS BEEN GIVEN ADEQUATE TIME TO COOL DOWN.

Correct maintenance is vital for smooth operation of the burner in order to avoid wasting fuel and causing atmospheric pollution.

This heater should be inspected, cleaned and serviced annually by a qualified service engineer. Unauthorised persons should not attempt to carry out repairs of the burner components. In the event of damage or broken components, replacements are available from Clarke Parts & Service Department.

CLEANING

1. Use a damp cloth wrung out in a solution of soapy water to clean the exterior of the heater. Use mild household cleaners on difficult spots.
2. Never use abrasive cleaners as they may damage the paint finish.
3. If you suspect the fuel has become contaminated with dirt or water, empty the tank and refill with fresh fuel.
4. The fuel filter should be removed and inspected for cleanliness before refilling the tank. If foul, remove and clean if necessary by rinsing in clean fuel.
5. The internal heating surfaces and combustion chamber of the burner should be cleaned at least annually during servicing. This task should be left to the Clarke Service Department.

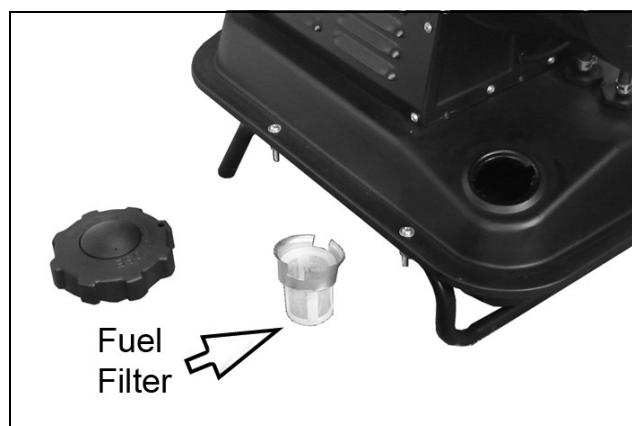

NOTE: Do not attempt to service the heater yourself. Servicing and maintenance should be left to the Clarke Service Department.

STORAGE

1. For long term storage, always store the heater in a dry, well ventilated space. Stand in a level position when filled, or fuel leakage may occur. It is recommended to completely fill the tank with fuel for extended storage to minimize condensation inside the tank.

DECLARATIONS OF CONFORMITY

UKCA

Clarke
INTERNATIONAL

Hemnell Street, Epping, Essex, CM16 4LG

DECLARATION OF CONFORMITY

This is an important document and should be retained.

We hereby declare that this product(s) complies with the following legislation:

The Electromagnetic Compatibility Regulations 2016
The Electrical Equipment (Safety) Regulations 2016
The Restriction of the Use of Certain Hazardous Substances in Electrical and Electronic Equipment Regulations 2012

The following standards have been applied to the product(s):

EN 60335-1:2012+A11:2014+A13:2017+A14:2019+A14:2019+A2:2019+A15:2021, EN 62321-2:2014, EN 61000-3-3:2013+A1:2019+A2:2021, EN IEC 61000-3-2:2019+A1:2021, EN 60335-2-102:2016, EN 62321-4:2014/A1:2017, EN 62321-5:2014, EN 62321-6:2015, EN 62321-8:2017, EN 62323:2008, EN IEC 55014-1:2021, EN IEC 55014-2:2021, EN 62321-7-1:2015, EN 62321-7-2:2017, EN 62321-3-1:2014, EN 13842:2004

The technical documentation required to demonstrate that the product(s) meet(s) the requirement(s) of the aforementioned legislation has been compiled and is available for inspection by the relevant enforcement authorities.

The UKCA mark was first applied in: 2021

Product Description: Space Heater
Model Number(s): DEVIL IRD208
Serial/Batch Number: Refer to product/packaging label
Date of Issue: 11/06/2024

Signed: 
J.A. Clarke
Director

DEVIL IRD208 UKCA Clarke DOC 061124 Page 1 of 1

CE

Clarke
INTERNATIONAL

Fitzwilliam Hall, Fitzwilliam Place, Dublin 2

DECLARATION OF CONFORMITY

This is an important document and should be retained.

We hereby declare that this product(s) complies with the following legislation:

2014/30/EU Electromagnetic Compatibility Directive
2014/35/EU Low Voltage Directive
2011/65/EU Restriction of Hazardous Substances (RoHS) Directive

The following standards have been applied to the product(s):

EN 60335-1:2012+A11:2014+A13:2017+A14:2019+A14:2019+A2:2019+A15:2021, EN 62321-2:2014, EN 61000-3-3:2013+A1:2019+A2:2021, EN IEC 61000-3-2:2019+A1:2021, EN 60335-2-102:2016, EN 62321-4:2014/A1:2017, EN 62321-5:2014, EN 62321-6:2015, EN 62321-8:2017, EN 62323:2008, EN IEC 55014-1:2021, EN IEC 55014-2:2021, EN 62321-7-1:2015, EN 62321-7-2:2017, EN 62321-3-1:2014, EN 13842:2004

The technical documentation required to demonstrate that the product(s) meet(s) the requirement(s) of the aforementioned legislation has been compiled and is available for inspection by the relevant enforcement authorities.

The CE mark was first applied in: 2017

Product Description: Space Heater
Model Number(s): DEVIL IRD208
Serial/Batch Number: Refer to product/packaging label
Date of Issue: 11/06/2024

Signed: 
J.A. Clarke
Director

DEVIL IRD208 CE Clarke DOC 061124 Page 1 of 1

A SELECTION FROM THE VAST RANGE OF

Clarke®

QUALITY PRODUCTS



AIR COMPRESSORS
From DIY to industrial, Plus air tools, spray guns and accessories.

GENERATORS
Prime duty or emergency standby for business, home and leisure.

POWER WASHERS
Hot and cold, electric and engine driven - we have what you need

WELDERS
Mig, Arc, Tig and Spot. From DIY to auto/industrial.

METALWORKING
Drills, grinders and saws for DIY and professional use.

WOODWORKING
Saws, sanders, lathes, mortisers and dust extraction.

HYDRAULICS
Cranes, body repair kits, transmission jacks for all types of workshop use.

WATER PUMPS
Submersible, electric and engine driven for DIY, agriculture and industry.

POWERTOOLS
Angle grinders, cordless drill sets, saws and sanders.

STARTERS/CHARGERS
All sizes for car and commercial use.



PARTS & SERVICE: 0208 988 7400

Parts Enquiries
Parts@clarkeinternational.com

Servicing & Technical Enquiries
Service@clarkeinternational.com

SALES: UK 01992 565333 or Export 00 44 (0)1992 565335

Clarke® INTERNATIONAL Hemnall Street, Epping, Essex CM16 4LG
www.clarkeinternational.com